

BC-200

Room Analysis Camera

User Manual - English

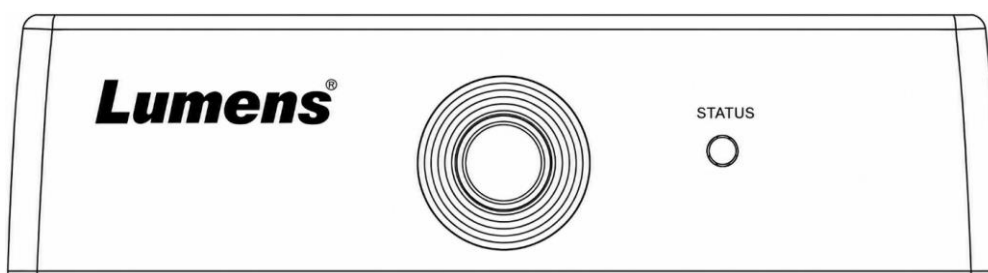

To download the latest Quick Start Guide, multilingual user manual, firmware, drivers, and control modules, please visit

<https://www.MyLumens.com/support>

Table of Contents

Chapter 1.	Package Contents	2
Chapter 2.	Overview	3
2.1	Overview	3
2.2	LED Indicators	3
Chapter 3.	Installation Instructions.....	4
3.1	System diagram.....	4
3.2	Installation Notes.....	4
Chapter 4.	Network setting and Web interface	6
4.1	Connecting Camera to Network.....	6
4.2	Use a Browser to view Images	6
4.3	Web interface functions	7
Chapter 5.	Microphone Relative Position.....	13
Chapter 6.	Troubleshooting.....	14
Chapter 7.	Safety Instructions	15
	Copyright Information	17

Chapter 1. Package Contents

BC-200



Mount

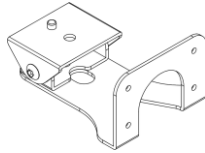

1/4-20UNC Screw

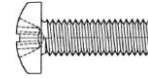

Chapter 2. Overview

2.1 Overview

Front

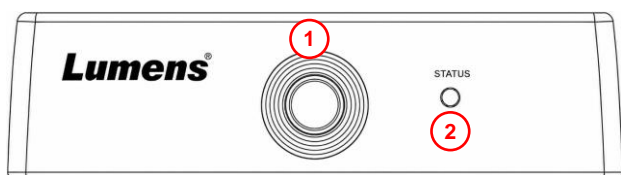

Back

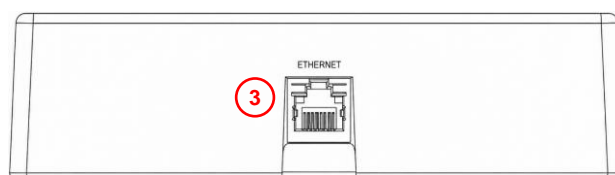

NO.	Item	Description
1.	Camera lens	高清攝像鏡頭
2.	LED Indicator	Displaying the status of the camera, refer to 2.2 LED Indicators
3.	Ethernet	Network port, support PoE (IEEE802.3af)

2.2 LED Indicators

LED	Status
No light	Power not connected
Green	Power on (In use)
Orange	Standby. Firmware update completed. Waiting for system reboot..
Red blinking	Firmware updating. Note Do not operate or turn off the power of the device during the update to avoid firmware failure
Orange blinking	Booting up or system restarting.

Chapter 3. Installation Instructions

3.1 System diagram

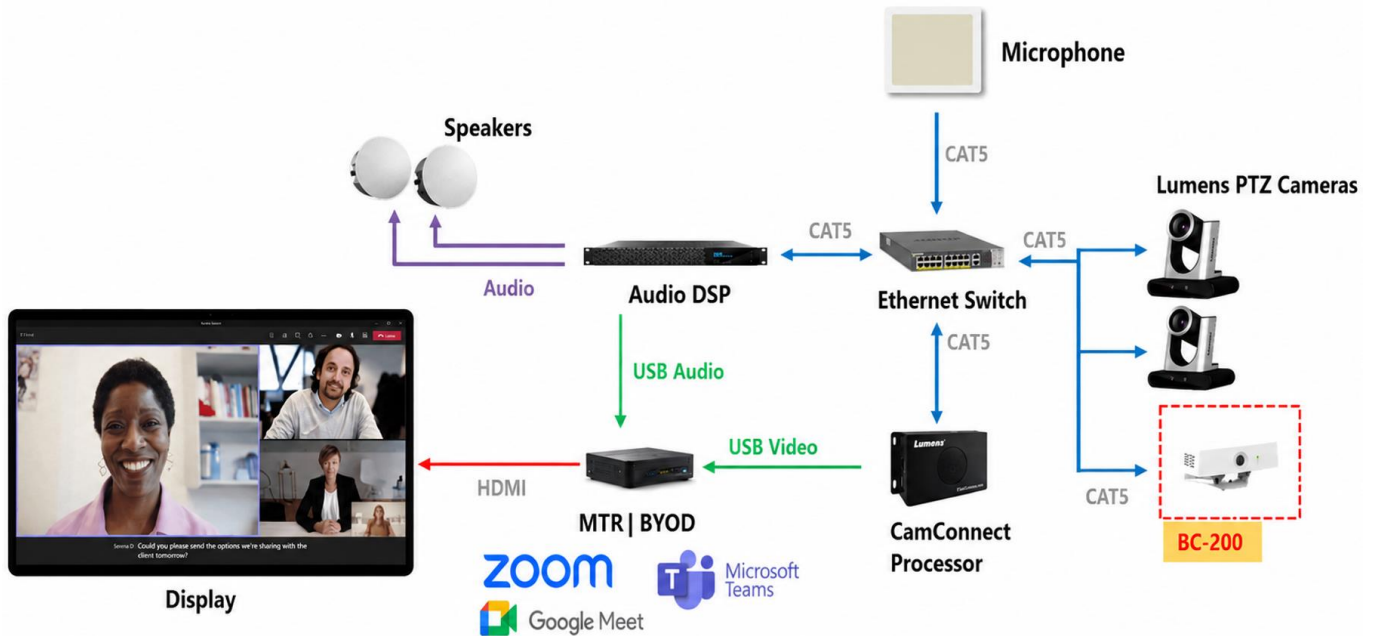

3.2 Installation Notes

3.2.1 Installation Personnel

Two-person installation is recommended for calibration and setup. (No more than five people in the area during tracking tests to minimize potential interference..)

3.2.2 Microphone Installation

To ensure accurate audio localization, align the ceiling microphone's 0° direction toward the front display or primary screen.

Here are approaches to verify the correct installation angle:

- Align the microphone logo toward the display.
- Verify the 0° sound direction in the microphone web interface while speaking in front of the display. (For Sennheiser microphones, please use the second method.)

3.2.3 BC-200 Installation

Mount the device securely on the wall using an approved bracket, to maximize the shooting range and effectiveness.

- Supported Detection Range: 1.5-8 meters
- When using multiple BC-200, ensure all devices and target remain within the detection range.
- Horizontal of View (HOV): 54°

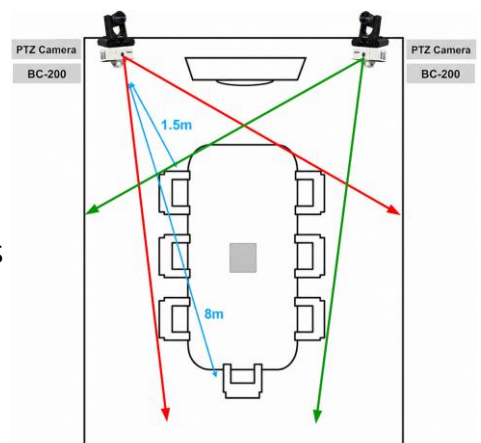

3.2.4 BC-200 Installation Method

Install the mounting bracket to install the device in an upright position
Alternatively, mount the BC-200 inverted underneath the VC-WM14 camera bracket, as shown.

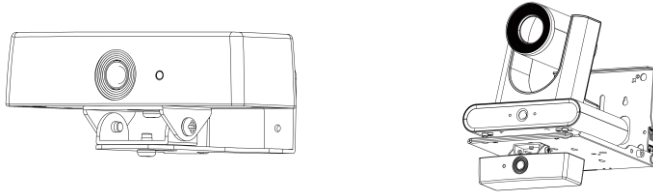

3.2.5 Camera Dimension

- Length x Width x Height: 144.39 x 56.22x 38.2mm
- Weight: 0.25Kg

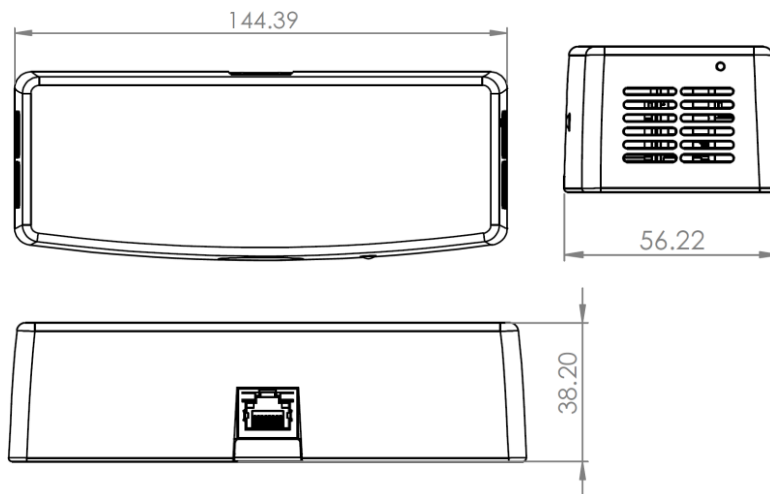

3.2.6 Dimensions of the base

The camera can be mounted on a 1/4" -20 UNC PTZ tripod head by using the locking holes on the bottom.

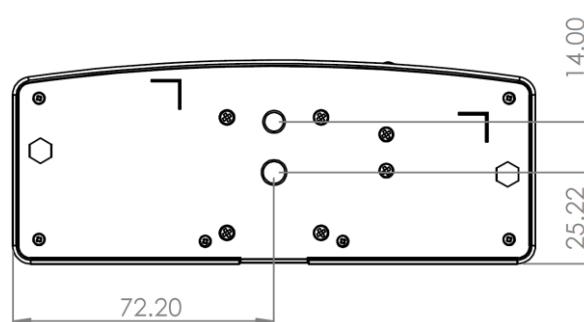

Chapter 4. Network setting and Web interface

4.1 Connecting Camera to Network

Two common connection methods are shown below

1. Connect via switch or router



2. Connect directly via an Ethernet cable. The computer's IP address must match the network segment used by the camera.

E.g. The camera's default IP address is 192.168.100.100. The computer's IP address should be set to the same segment, such as 192.168.100.101.

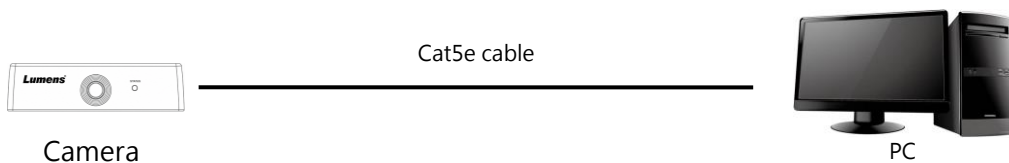

- Modify the PC's network settings

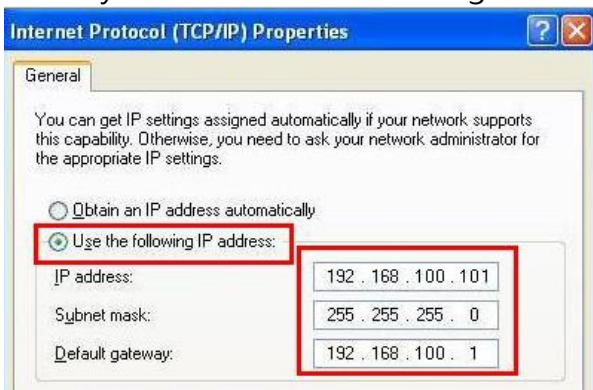

4.2 Use a Browser to view Images

- Open the browser, and enter the IP address of the camera in the address bar
E.g.: <http://192.168.100.100> (default IP address)
- Enter the Username and Password

Note Please refer to [4.3.6 Maintenance](#) to change the default password.

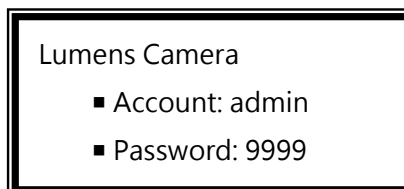

4.3 Web interface functions

4.3.1 Login

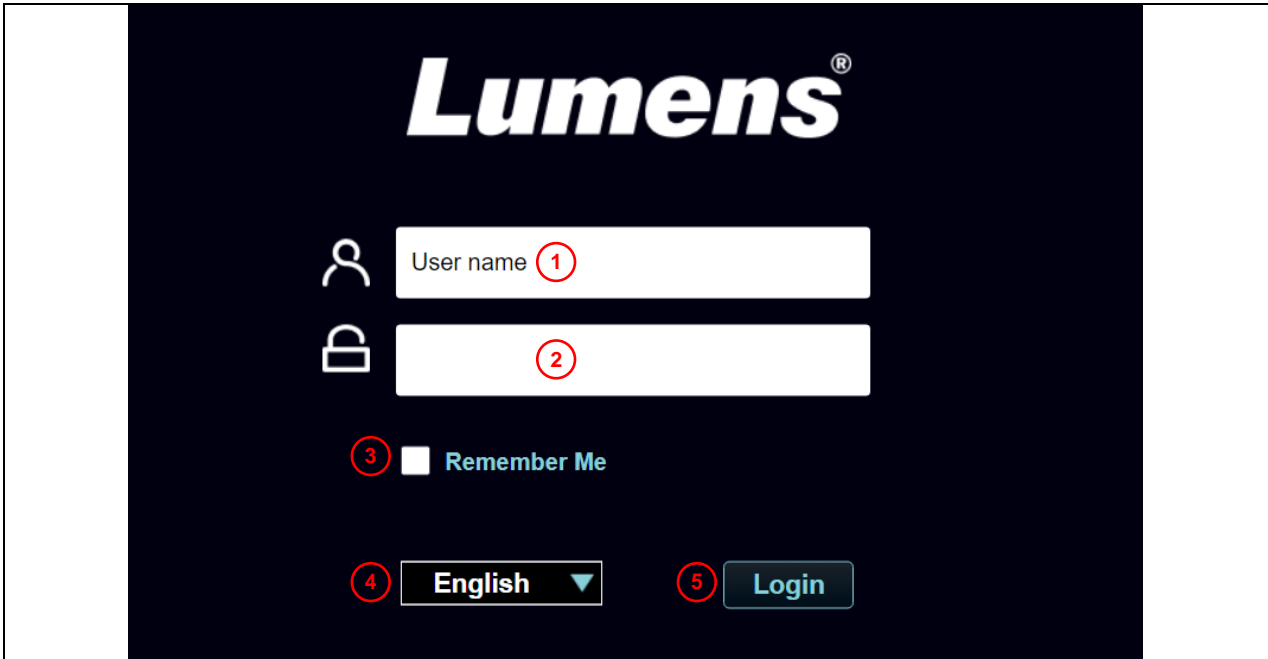

No	Item	Description
1	User name	Enter the user account name (default: admin).
2	Password	Enter the user password (default: 9999). <small>Note</small> For the initial login, please refer to 4.3.6 Maintenance to change the default password.
3	Remember Me	Save the user name and password. When you log in next time, there is no need to re-enter them
4	Language	Supports English/ Traditional Chinese/ Simplified Chinese
5	Login	Log into the web interface

4.3.2 Correction Setup

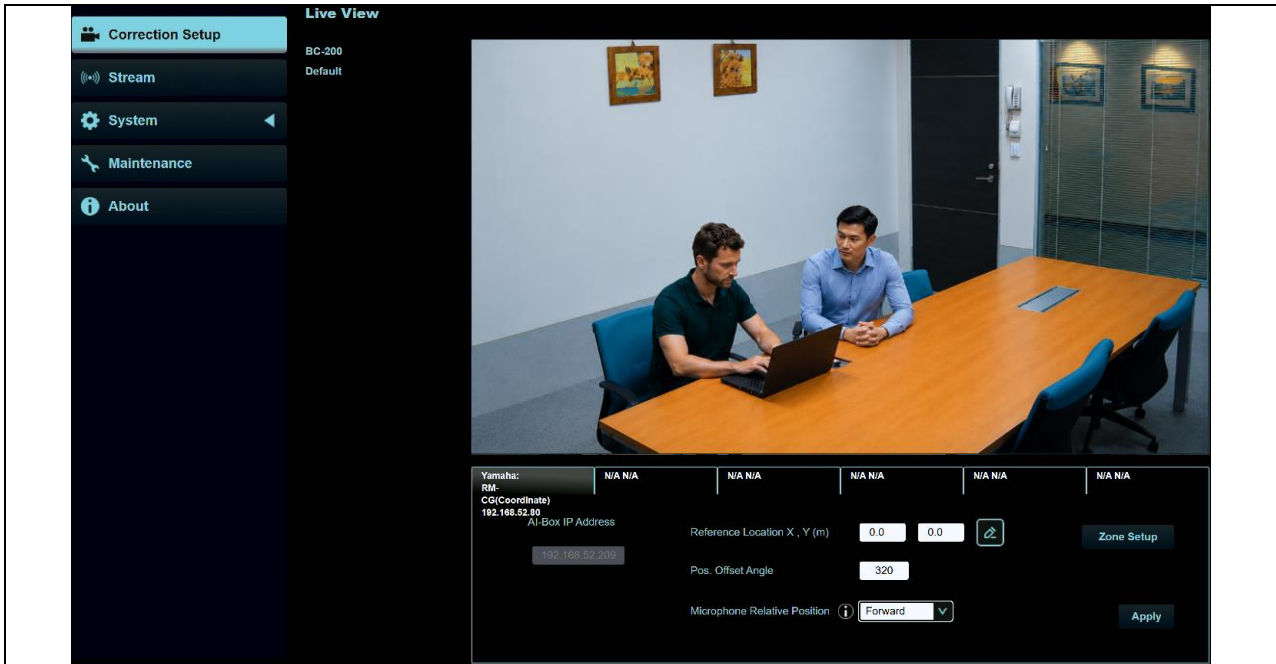

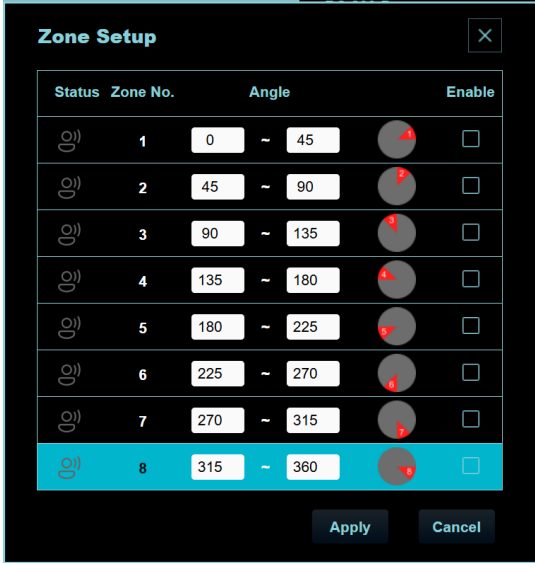
No	Item	Description
1	Camera ID/ Location	Displays the camera name and location. Refer to 4.3.5 System - Control
2	Connected Microphone	Displays the IP address of the connected microphone
3	Connected AI-Box1	Displays the IP address of the connected AI-Box1.
4	Reference Location	Displays the X and Y coordinates of the reference position.
5	Pos Offset Angle	Displays the position offset angle.
6	Microphone Relative Position	Select the microphone relative position. Refer to Chapter 5 Microphone Relative Position.
7	Zone Settings	Click to open the Zone Settings window. 
8	Apply	Apply Settings

4.3.3 Stream

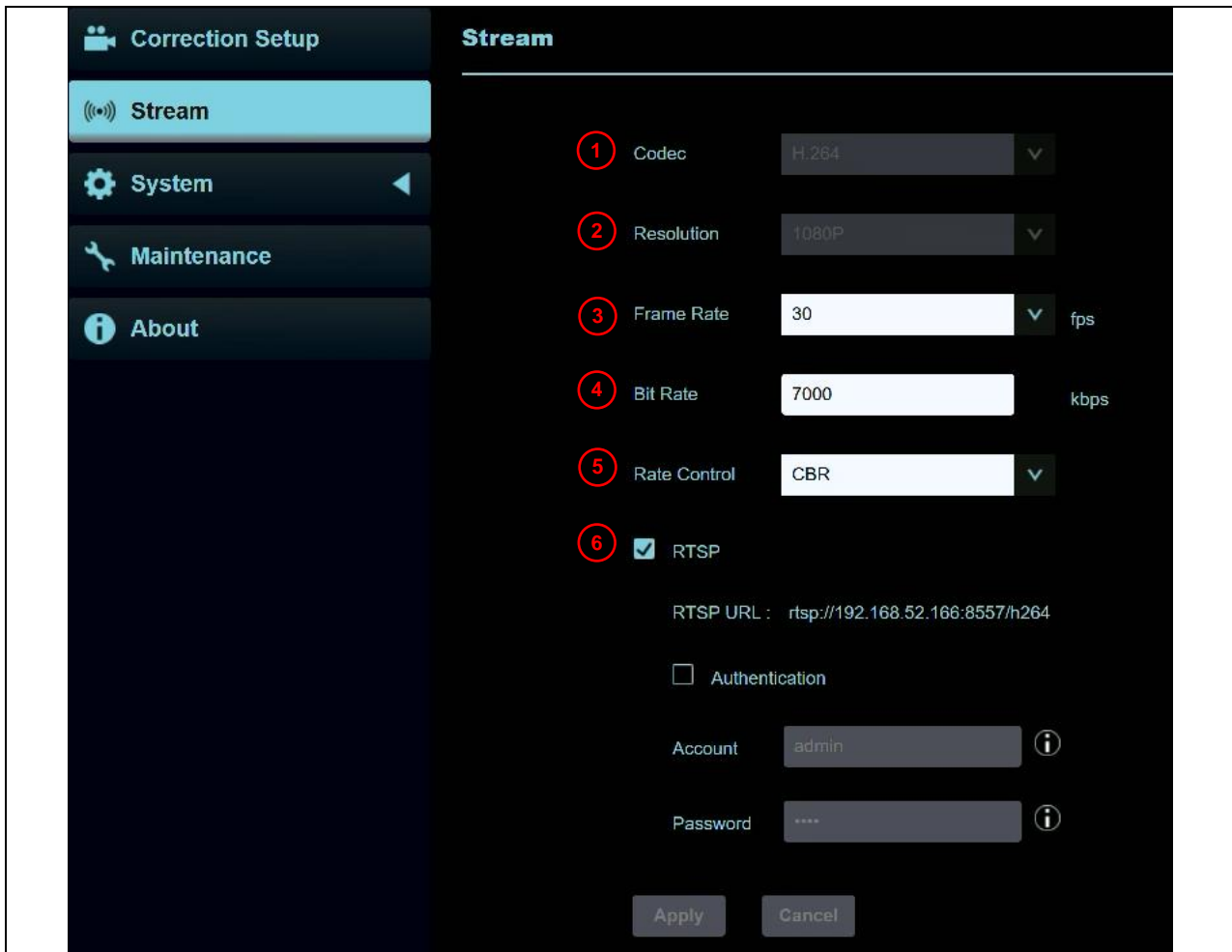

No	Item	Description
1	Codec	H.264
2	Resolution	1080p
3	Frame Rate	Support 30/ 25fps
4	Bit Rate	Setting range: 2,000~20,000 kbps (Default 7,000 kbps)
5	Rate Control	Support CBR / VBR
6	RTSP	<p>Check to enable the RTSP stream.</p> <ul style="list-style-type: none"> ■ RTSP URL: <u>rtsp://<IP Address>:8557/h264</u> ■ Enable/ disable authentication <ul style="list-style-type: none"> ➢ Account: <ul style="list-style-type: none"> -Support 5-16 characters. -Support letters, numbers, and underscores (_). ➢ Password: <ul style="list-style-type: none"> -Supports 8- 31 characters. - Support letters, numbers, and underscores (_). -Must contain letters and numbers.

4.3.4 System - Network

Network

DHCP

IP Address

Netmask

Gateway

DNS

MAC Address

Description

Camera Network Settings
 Network settings can be modified when the DHCP function is disabled.
 After making changes, click [Apply] to save and apply the settings.

4.3.5 System - Control

Control

1 Image Mirror - Flip

2 Led Status

5

Device

3 Camera Name

Location

4

No	Item	Description
1	Image Mirror - Flip	Configure image mirroring and flipping.

2	Led Status	Enable/ disable the LED indicator.
3	Camera Name/ Location	Displays the camera name and location. <ul style="list-style-type: none"> ■ Modifying this field will also update the ONVIF device name/location. ■ Support up to 32 characters ■ Support Chinese characters
4	Apply/ Cancel	Apply/ Cancel the settings.

4.3.6 Maintenance

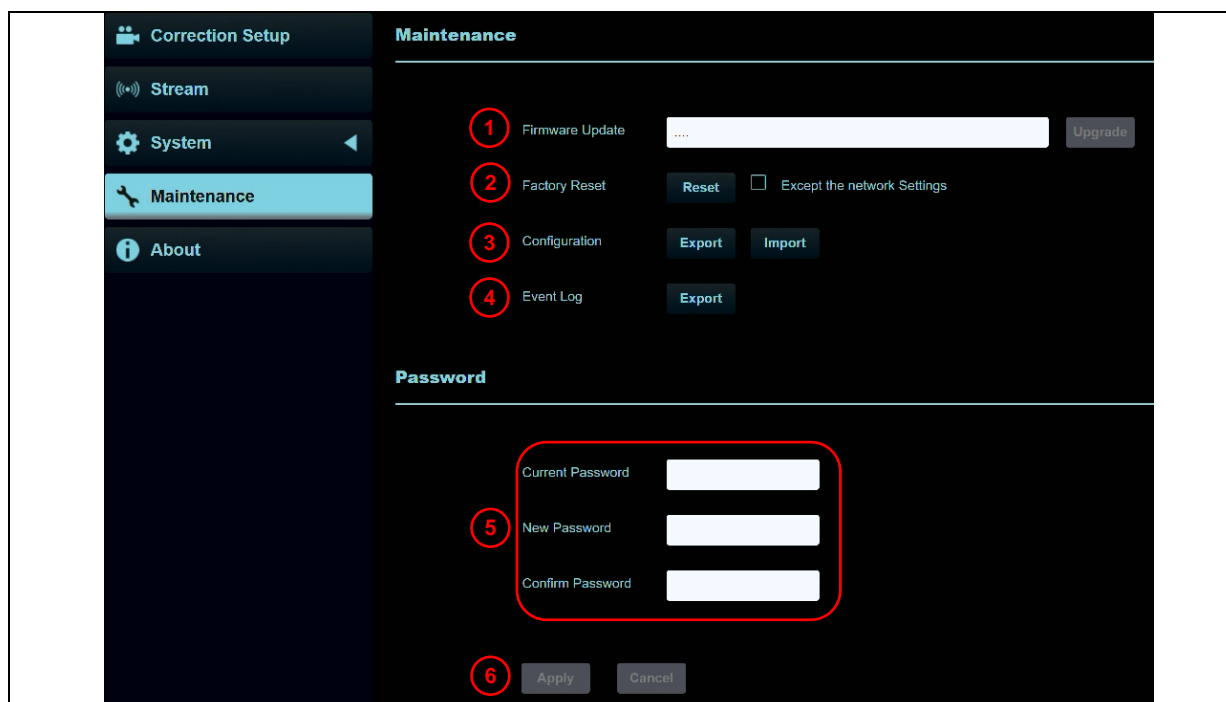

No	Item	Description
1	Firmware Update	Click [...] to select the firmware file and click [Upgrade] to start updating <div style="border: 1px solid gray; padding: 2px; width: fit-content;">Note</div> <ul style="list-style-type: none"> ■ The update process takes 2-3 minutes ■ Do not operate or turn off the power of the device during the update to avoid firmware failure
2	Factory Reset	Reset all configurations to default setting
3	Configuration	Save the current settings as a configuration file. Users can download or upload camera configuration files.
4	Event Log	If the camera operates abnormally, please export event log and provide it to Lumens for investigation
5	Password	Change the login password. <ul style="list-style-type: none"> ■ Username and password: 4–32 characters. ■ Support letters and numbers. Special characters and symbols are not allowed.
6	Apply/ Cancel	Apply/ Cancel the settings.

4.3.7 About



Description

Display the firmware version, serial number, and other related information.
For technical support, please scan the QR code at the bottom right.

Chapter 5. Microphone Relative Position

■ Yamaha RM-CG

Logo positioned in the top-left corner



■ Sennheiser TCC2

Logo positioned at the bottom

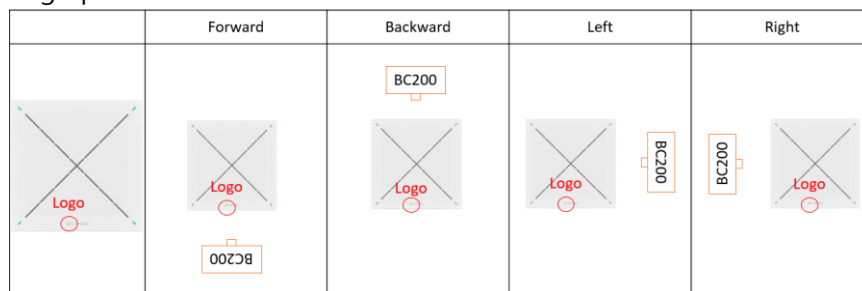

■ Sennheiser TCCM

Logo is positioned to the left side of the microphone at 0°

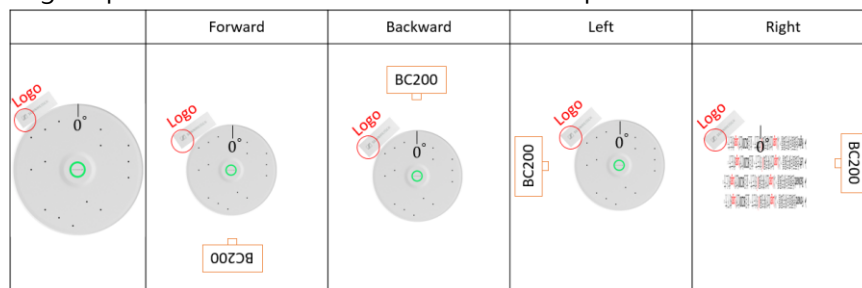

■ Shure920

Logo positioned in the top-left corner

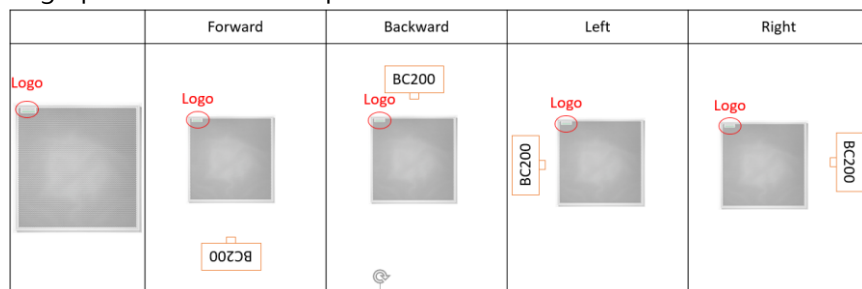

Chapter 6. Troubleshooting

This chapter describes problems you may encounter while using the camera. If you have questions, please refer to related chapters and follow all the suggested solutions.

If the problem still occurs, please contact your local distributor or Lumens.

No.	Problems	Solutions
1.	No power to the device	Ensure the power supply supports PoE (IEEE802.3af)
2.	ONVIF software cannot discover the camera	Please make sure that [System]> [Control]> [Camera ID]/[Location] in the web page uses only English letters or numbers. The ONVIF software cannot find the camera if you use special symbols or space.
3.	Forgot the web login username or password	Please contact your local distributor or Lumens technical support
4.	Unable to select a firmware file when using the Safari browser for firmware updates	Use a different web browser, such as Google Chrome or Mozilla Firefox, to perform the firmware update.
5.	Configuration settings are lost after a power cycle and revert to the previous values	<p>If the device disconnect power immediately after modifying settings, the new settings may not have been saved yet. After the device restarts, the previous settings will be restored.</p> <p>Last Memory Save Mechanism:</p> <ul style="list-style-type: none">■ The system checks every 30 seconds for parameter changes that need to be saved.■ When the device is shut down using the Power On/Off button, the current settings are automatically saved. <p>Recommendation:</p> <p>After modifying any settings, wait at least 30 seconds before powering off or restarting the device to ensure that the settings have been successfully saved.</p>

Chapter 7. Safety Instructions

Always follow these safety instructions when setting up and using PTZ Video Camera:

1 Operation

- 1.1 Please use the product in the recommended operating environment, away from water or source of heat
- 1.2 Do not place the product on a tilted position or unstable trolley, stand or table.
- 1.3 Please clean the dust on the power plug prior to usage. Do not insert the product's power plug into a multiplug to prevent sparks or a fire.
- 1.4 Do not block the slots and openings in the case of the product. They provide ventilation and prevent the product from overheating.
- 1.5 Do not open or remove covers, otherwise it may expose you to dangerous voltages and other hazards. Refer all servicing to licensed service personnel.
- 1.6 Unplug the product from the wall outlet and refer servicing to licensed service personnel when the following situations happen:
 - If the power cords are damaged or frayed.
 - If liquid is spilled into the product or the product has been exposed to rain or water.

2 Installation

- 2.1 For security considerations, please make sure the standard hanging rack you bought is in line with UL or CE safety approbations and installed by technician personnel approved by agents.



3 Storage

- 3.1 Do not place the product where the cord can be stepped on as this may result in fraying or damage to the lead or the plug.
- 3.2 Unplug the product during thunderstorms or if it is not going to be used for an extended period.
- 3.3 Do not place the product or accessories on top of vibrating equipment or heated objects.

4 Cleaning

- 4.1 Disconnect all the cables prior to cleaning and wipe the surface with a dry cloth. Do not use alcohol or volatile solvents for cleaning.

■ Precautions

	This symbol indicates that this equipment may contain dangerous voltage which could cause electric shock. Do not remove the cover (or back). No user-serviceable parts inside. Refer servicing to licensed service personnel.		WARNING
			This symbol indicates that there are important operating and maintenance instructions in this User Manual with this unit.

■ Battery Warning (for products or accessories with batteries)

General Safety Warnings:

- Do not heat or dispose of the battery in fire, as it may explode or leak.
- Avoid short-circuiting: Do not connect the positive and negative terminals directly or use metallic objects to connect them.
- Do not disassemble, crush, puncture, or modify the battery.
- Do not immerse the battery in water or any other liquids.

Usage and Storage Warnings:

- Do not store the battery in high-temperature environments (above 60°C) or in areas with high humidity.
- Keep away from direct sunlight and heat sources.
- If not in use for a long period, remove the battery and store it in a cool, dry place.

Disposal and Recycling Warnings:

- Do not dispose of the battery in household waste; follow local regulations for proper disposal and recycling.
- If leakage occurs, avoid contact with the leaked substance and clean the affected area immediately.

Child Safety Warnings:

- This product contains a button battery. Ingestion of a button battery can cause severe internal burns within 2 hours and may result in death.
- If a battery is swallowed or if internal battery material is contacted, seek medical attention immediately.
- Store batteries (whether new or used) in a place that is out of reach of children.
- If the battery compartment does not close securely, stop using the product and keep it away from children.

■ **FCC Warning**

This equipment has been tested and found to comply with the limits for a Class A digital device, pursuant to part 15 of the FCC Rules. These limits are designed to provide reasonable protection against harmful interference when the equipment is operated in a commercial environment.

Notice :

The changes or modifications not expressly approved by the party responsible for compliance could void the user' s authority to operate the equipment.

■ **IC Warning**

This digital apparatus does not exceed the Class A limits for radio noise emissions from digital apparatus as set out in the interference-causing equipment standard entitled "Digital Apparatus," ICES-003 of Industry Canada.

Cet appareil numérique respecte les limites de bruits radioélectriques applicables aux appareils numériques de Classe A prescrites dans la norme sur le matériel brouilleur: "Appareils Numériques," NMB-003 édictée par l'Industrie.

■ **EN55032 CE Warning**

Operation of this equipment in a residential environment could cause radio interference.

Copyright Information

Copyrights © Lumens Digital Optics Inc. All rights reserved.

Lumens is a trademark registered by Lumens Digital Optics Inc.

Copying, reproducing or transmitting this file is not allowed if a license is not provided by Lumens Digital Optics Inc. unless copying this file is for the purpose of backup after purchasing this product.

In order to keep improving the product, the information in this file is subject to change without prior notice.

To fully explain or describe how this product should be used, this manual may refer to names of other products or companies without any intention of infringement.

Disclaimer of warranties: Lumens Digital Optics Inc. is neither responsible for any possible technological, editorial errors or omissions, nor responsible for any incidental or related damages arising from providing this file, using, or operating this product.